

PERFORMANCE
MADE
SMARTER

Product manual

9410

Power control unit

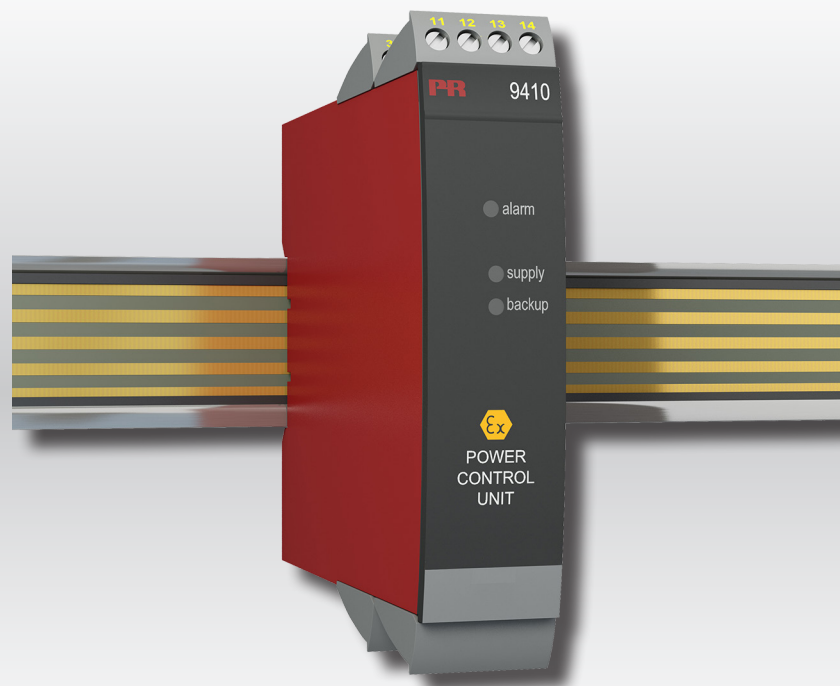

Segurança
INMETRO



TEMPERATURE | I.S. INTERFACES | COMMUNICATION INTERFACES | MULTIFUNCTIONAL | ISOLATION | DISPLAY

No. 9410V107-UK
Product version: 9410-001

PR
electronics

6 Product Pillars

to meet your every need

Individually outstanding, unrivalled in combination

With our innovative, patented technologies, we make signal conditioning smarter and simpler. Our portfolio is composed of six product areas, where we offer a wide range of analog and digital devices covering over a thousand applications in industrial and factory automation. All our products comply with or surpass the highest industry standards, ensuring reliability in even the harshest of environments and have a 5-year warranty for greater peace of mind.



Temperature

Our range of temperature transmitters and sensors provides the highest level of signal integrity from the measurement point to your control system. You can convert industrial process temperature signals to analog, bus or digital communications using a highly reliable point-to-point solution with a fast response time, automatic self-calibration, sensor error detection, low drift, and top EMC performance in any environment.



I.S. Interface

We deliver the safest signals by validating our products against the toughest safety standards. Through our commitment to innovation, we have made pioneering achievements in developing I.S. interfaces with SIL 2 Full Assessment that are both efficient and cost-effective. Our comprehensive range of analog and digital intrinsically safe isolation barriers offers multifunctional inputs and outputs, making PR an easy-to-implement site standard. Our backplanes further simplify large installations and provide seamless integration to standard DCS systems.



Communication

We provide inexpensive, easy-to-use, future-ready communication interfaces that can access your PR installed base of products. All the interfaces are detachable, have a built-in display for readout of process values and diagnostics, and can be configured via push-buttons. Product specific functionality includes communication via Modbus and Bluetooth and remote access using our PR Process Supervisor (PPS) application, available for iOS and Android.



Multifunction

Our unique range of single devices covering multiple applications is easily deployable as your site standard. Having one variant that applies to a broad range of applications can reduce your installation time and training, and greatly simplify spare parts management at your facilities. Our devices are designed for long-term signal accuracy, low power consumption, immunity to electrical noise and simple programming.



Isolation

Our compact, fast, high-quality 6 mm isolators are based on microprocessor technology to provide exceptional performance and EMC-immunity for dedicated applications at a very low total cost of ownership. They can be stacked both vertically and horizontally with no air gap separation between units required.



Display

Our display range is characterized by its flexibility and stability. The devices meet nearly every demand for display readout of process signals and have universal input and power supply capabilities. They provide a real-time measurement of your process value no matter the industry and are engineered to provide a user-friendly and reliable relay of information, even in demanding environments.

Power control unit

9410

Table of contents

Warning	4
Symbol identification	4
Safety instructions	4
Marking	5
How to demount system 9000	6
Application and advanced features	7
Technical characteristics	7
Applications	8
Order	9
Electrical specifications	9
Connections	11
Block diagram	12
IECEX Installation Drawing	13
ATEX Installation Drawing	16
FM Installation Drawing	19
UL Installation Drawing	22
INMETRO Installation Drawing	25
KCs IECEX Installation Drawing	28
Document history	31

Warning



The following operations should only be carried out on a disconnected device and under ESD-safe conditions:

- General mounting, wire connection and disconnection.
- Troubleshooting the device.

Repair of the device and replacement of circuit breakers must be done by PR electronics A/S only.

Symbol identification



Triangle with an exclamation mark: Read the manual before installation and commissioning of the device in order to avoid incidents that could lead to personal injury or mechanical damage.



The CE mark proves the compliance of the device with the essential requirements of the EU-directives.



The UKCA mark proves the compliance of the device with the essential requirements of the UK regulations.



The double insulation symbol shows that the device is protected by double or reinforced insulation.



Ex devices have been approved according to the ATEX directive / UKEX regulations for use in connection with installations in explosive areas.

Safety instructions

Definitions

Hazardous voltages have been defined as the ranges: 75 to 1500 Volt DC, and 50 to 1000 Volt AC.

Technicians are qualified persons educated or trained to mount, operate, and also trouble-shoot technically correct and in accordance with safety regulations.

Operators, being familiar with the contents of this manual, adjust and operate the knobs or potentiometers during normal operation.

Receipt and unpacking

Unpack the device without damaging it and check whether the device type corresponds to the one ordered. The packing should always follow the device until this has been permanently mounted.

Environment

Avoid direct sun light, dust, high temperatures, mechanical vibrations and shock, and rain and heavy moisture. If necessary, heating in excess of the stated limits for ambient temperatures should be avoided by way of ventilation.

The device must be installed in pollution degree 2 or better.

The device is designed to be safe at least under an altitude up to 2 000 m.

The device is designed for indoor use.

Mounting

Only technicians, who are familiar with the technical terms, warnings, and instructions in the manual and who are able to follow these, should connect the device. Should there be any doubt as to the correct handling of the device, please contact your local distributor or, alternatively,

PR electronics A/S
www.prelectronics.com

Mounting and connection of the device should comply with national legislation for mounting of electric materials, i.a. wire cross section, protective fuse, and location.

The use of stranded wires is not permitted for mains wiring except when wires are fitted with cable ends.

Stranded wire should be installed with an insulation stripping length of 5 mm or via a suitable insulated terminal such as a bootlace ferrule.

Descriptions of input / output and supply connections are shown in the block diagram and on the side label.

The device is provided with field wiring terminals and shall be supplied from a Power Supply having double / reinforced insulation. A power switch shall be easily accessible and close to the device. The power switch shall be marked as the disconnecting unit for the device.

Year of manufacture can be taken from the first two digits in the serial number.

Calibration and adjustment

During calibration and adjustment, the measuring and connection of external voltages must be carried out according to the specifications of this manual. The technician must use tools and instruments that are safe to use.

Normal operation

Operators are only allowed to adjust and operate devices that are safely fixed in panels, etc., thus avoiding the danger of personal injury and damage. This means there is no electrical shock hazard, and the device is easily accessible.

Cleaning

When disconnected, the device may be cleaned with a cloth moistened with distilled water.

Liability

To the extent the instructions in this manual are not strictly observed, the customer cannot advance a demand against PR electronics A/S that would otherwise exist according to the concluded sales agreement.

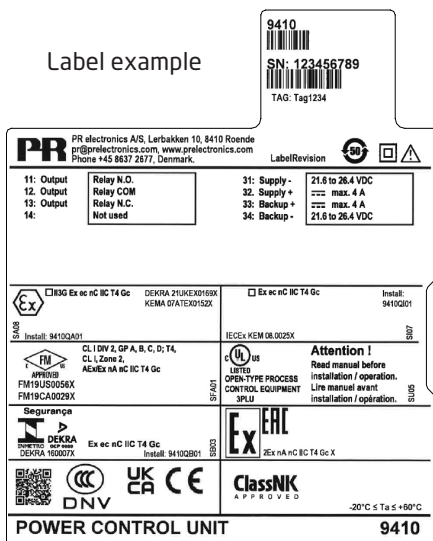

Marking

When this product has been installed as Ex ec, use a permanent marker in the appropriate box to indicate the type of installation on the label.

How to demount system 9000

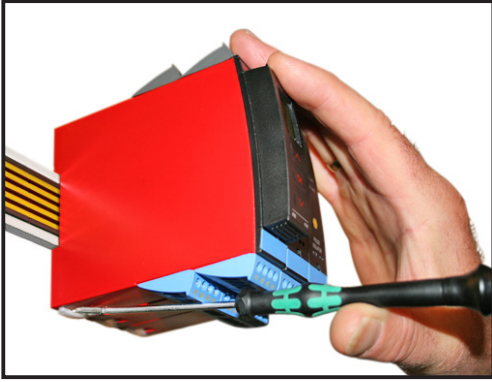

Picture 1:

By lifting the bottom lock, the device is detached from the DIN rail.

Power control unit

9410

- Distributes supply voltage to the power rail
- Optional connection of backup supply
- Approved for installation in Ex zone 2 / Div. 2
- Optional redundant supply for the power rail
- Must be installed on power rail, PR type 9400

Application and advanced features

- The power control unit detects errors from any of the devices mounted on the power rail and transmits a collective alarm to the control system via the internal status relay.
- Optional connection of two power supplies - a primary supply and a backup supply.
- Redundant supply for the power rail can be obtained by mounting two 9410 devices connected to 2 separate power supplies.

Technical characteristics

- The status relay will be energised (pins 11 & 12) when the following three conditions are met:
 1. Supply voltage is present on pins 31 and 32.
 2. Backup supply voltage is present on pins 34 and 33. (If the backup supply is not in use, a jumper must be placed between pins 32 and 33 - the jumper is delivered with the device).
 3. There are no error signals from the devices connected to the power rail.
- When a collective alarm is activated via the power rail, the status relay in the 9410 will be de-energised (pins 13 & 12).
- Two green front LEDs indicate connection of supply and backup.
- A red LED indicates error status.

Applications

Device status relay from power rail

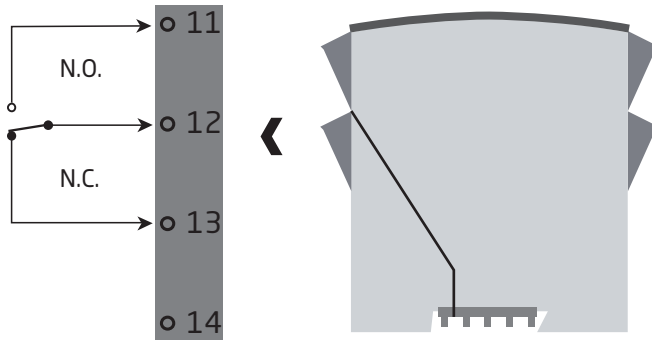

Power connection

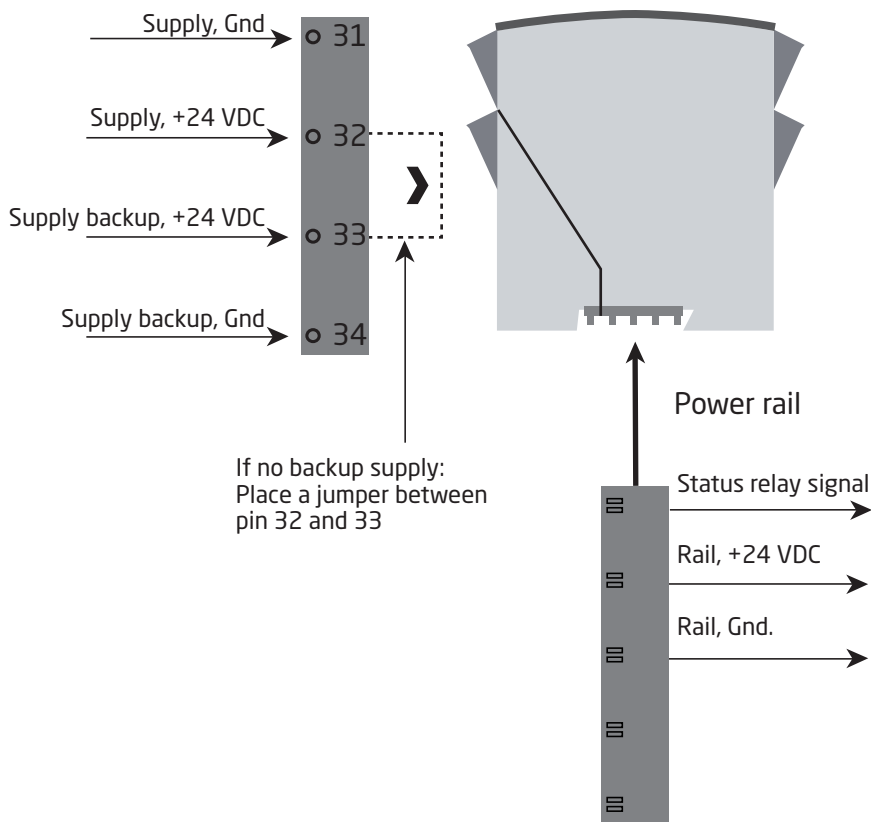

Zone 2 & Cl. 1, Div. 2, gr. A-D or Safe Area

Order

Type	Ex approvals
9410	ATEX, IECEx, FM, INMETRO, CCC, EAC-Ex, UKEX : -
	UL 913, ATEX, IECEx, FM, INMETRO, CCC, EAC-Ex, UKEX : -U9
	KCs, ATEX, IECEx, FM, INMETRO, CCC, EAC-Ex, UKEX : -KCs

Example: 9410-U9

Electrical specifications

Environmental conditions

Specifications range	-20...+60°C
Storage temperature	-20...+85°C
Relative humidity	< 95% RH (non-cond.)
Protection degree	IP20
Installation in	Pollution degree 2 & measurement / overvoltage category II

Mechanical specifications

Dimensions (HxBxD)	109 x 23.5 x 104 mm
Weight	140 g
DIN rail type	DIN EN 60715 / 35 mm
Wire size (min. / max.)	0.13...2.08 mm ² / AWG 26...14 stranded wire
Screw terminal torque	0.5 Nm
Vibration	IEC 60068-2-6
2...13.2 Hz	±1 mm
13.2...100 Hz	±0.7

Common specifications

Max. consumption	96 W
Efficiency	> 97,9%
Max. internal consumption	2 W

Input

Supply voltage, double / reinforced isolation	21.6...26.4 VDC
Backup supply	21.6...26.4 VDC
Trig levels for voltage surveillance	Error < 21 VDC

Output

Output voltage @ 4 A	Input voltage - 0.5 VDC
Output power, max.	96 W
Output current, max.	4 A
Output ripple	Samme as input ripple

Status relay in safe area

Max. voltage	250 VAC / 30 VDC
Max. current.	2 AAC / 2 ADC
Max. AC power	500 VA / 60 W

Observed authority requirements

EMC	2014/30/EU & UK SI 2016/1091
ATEX	2014/34/EU & UK SI 2016/1107
LVD	2014/35/EU & UK SI 2016/1101
RoHS	2011/65/EU & UK SI 2012/3032

Approvals

DNV-GL, Ships & Offshore	TAA00000JD
ClassNK	TA24034M
c UL us, UL 61010-1.	E314307
EAC	TR-CU 020/2011
EAC LVD	TR-CU 004/2011
EAC Ex	TR-CU 012/2011

I.S. / Ex

ATEX	KEMA 07ATEX0152 X
IECEX	IECEX KEM 08.0025X
UKEX	DEKRA 21UKEX0169 X
c FM us.	FM19US0056X / FM19CA0029X
INMETRO	DEKRA 16.0007 X
c UL us, UL 913 (only 9410-U9).	E233311
KCs (only 9410-KCs).	21-AV4B0-0185X
CCC	2020322303003230
EAC Ex	RU C-DK.HA65.B.00355/19

Connections

Inputs:

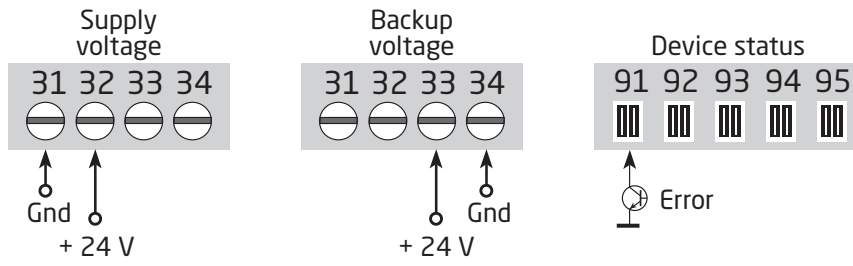

If no backup supply:
Place a jumper between
pin 32 and 33

Outputs:

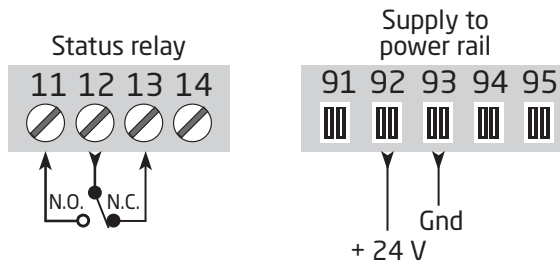

Block diagram

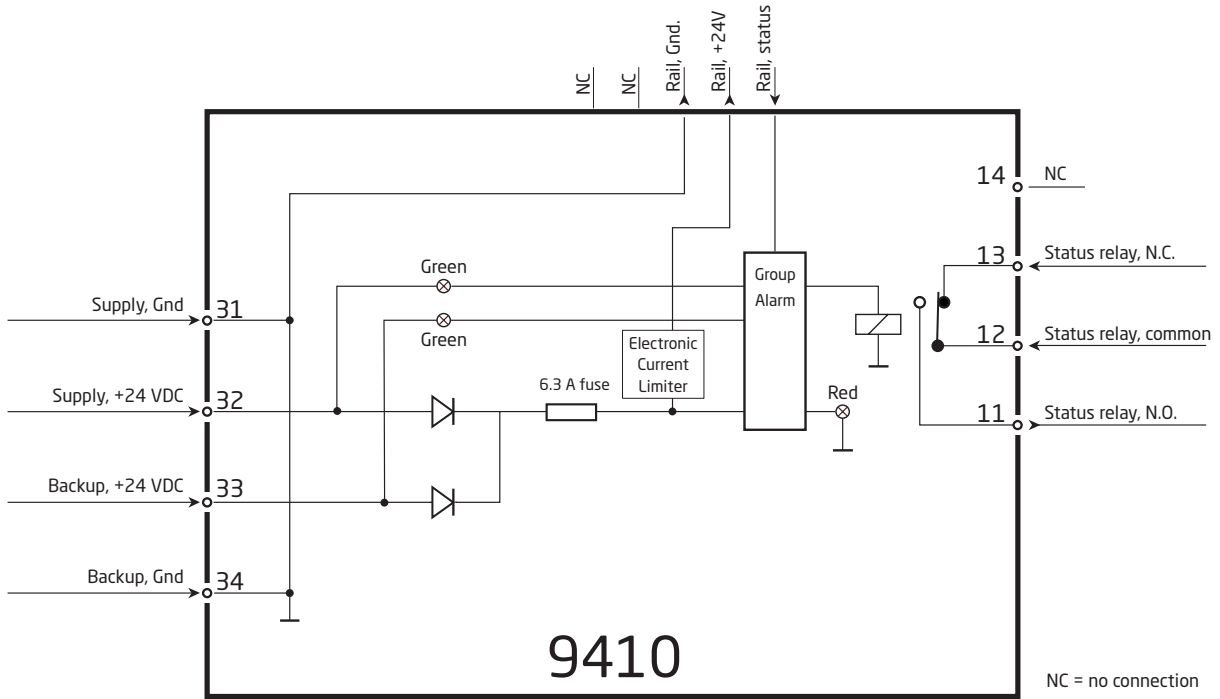

IECEX Installation drawing



9410

For safe installation of 9410 the following must be observed. The module shall only be installed by qualified personnel who are familiar with the national and international laws, directives and standards that apply to this area.

Year of manufacture can be taken from the first two digits in the serial number.

9410 Power Control Unit

IECEX Certificate IECEX KEM 08.0025 X

Marking: Ex ec nC IIC T4 Gc

Standards: IEC60079-0:2017, IEC60079-15:2017, IEC60079-7:2017

Non Hazardous Area or Zone 2

T4: -20 °C <Ta < +60°C

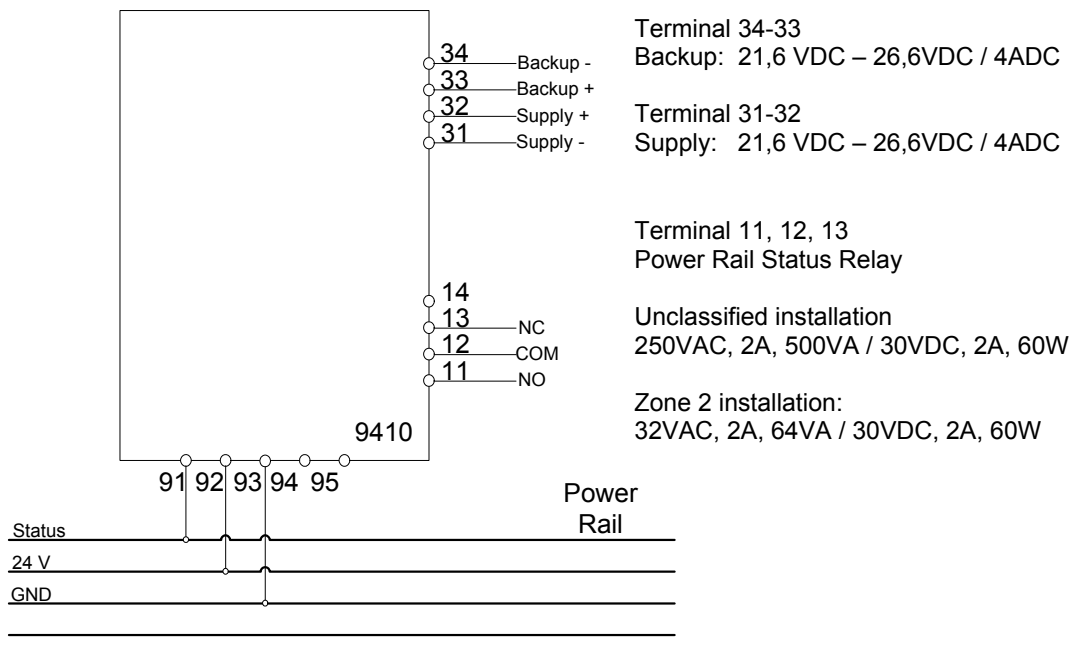

9410 Power Control with backup.



Use Endcaps to prevent the Power Rail from being short circuit by the outer enclosure.

Use 9400 Cover to prevent open Power Rail from unintentional short circuit.

Redundant 9410 Power Control with Backup.

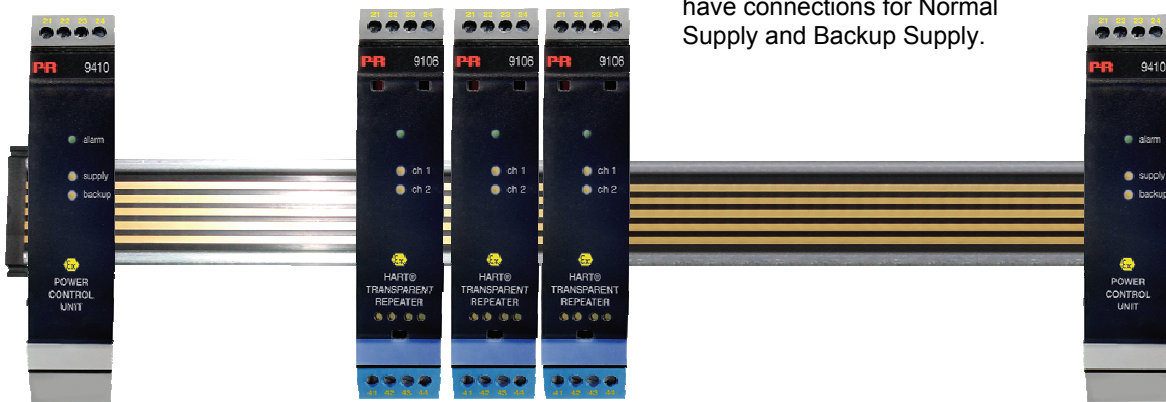

Power is supplied to the Power Rail from two 9410 Power Control Modules. Both modules have connections for Normal Supply and Backup Supply.

Installation notes:

General

The 9410 must be supplied from a Power Source with Double or Reinforced insulation to Mains.

Terminal blocks :

Wire size 0.13-2.08 mm² / AWG 26-14 stranded wire
Screw terminal torque 0.5 Nm

For installation in Zone 2

The Power Control Unit Type 9410 and Power Rail Type 9400 shall be installed in a controlled environment with suitably reduced pollution, limited to pollution degree 2 or better.

The circuit shall be limited to overvoltage category I/II as defined in IEC 60664-1.

The 9410 Power Control Unit and 9400 Power Rail must be installed in an outer enclosure having an IP protection of at least IP54, conforming to the requirements of explosion protection Ex-n or Ex-e.

Transients are suppressed by an internal transient protection device, which is set to a level not exceeding 40% of the rated voltage.

WARNING: Do not separate connectors when energized and an explosive gas mixture is present.

WARNING: Do not install or remove modules from the Power Rail unless Area is known to be Non Hazardous.

WARNING: Terminals 91,92,93,94,95 may only be connected to Power Rail 9400.

ATEX/UKEX Installation drawing



9410

For safe installation of 9410 the following must be observed. The module shall only be installed by qualified personnel who are familiar with the national and international laws, directives and standards that apply to this area.

Year of manufacture can be taken from the first two digits in the serial number.

9410 Power Control Unit

ATEX Certificate
UKEx Certificate

KEMA 07ATEX0152X
DEKRA 21UKEX0169 X

Marking:



II 3G Ex ec nC IIC T4 Gc

Standards:

EN60079-0:2018, EN60079-7:2015+A1, EN60079-15:2010

Non Hazardous Area or Zone 2

T4: -20 °C < Ta < +60°C

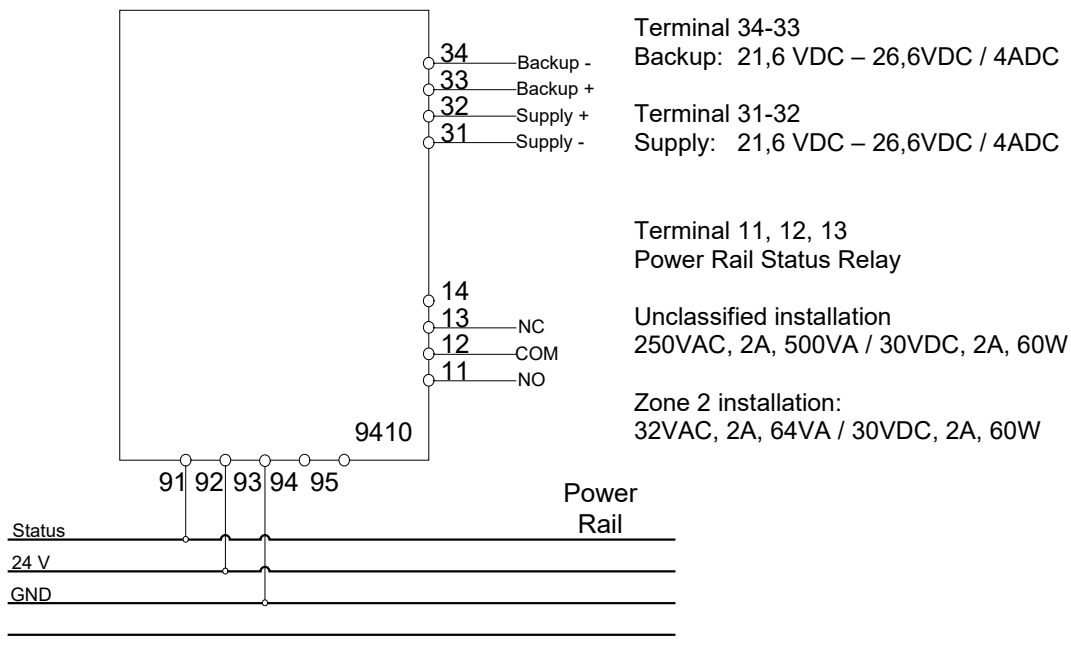

9410 Power Control with backup.



Redundant 9410 Power Control with Backup.

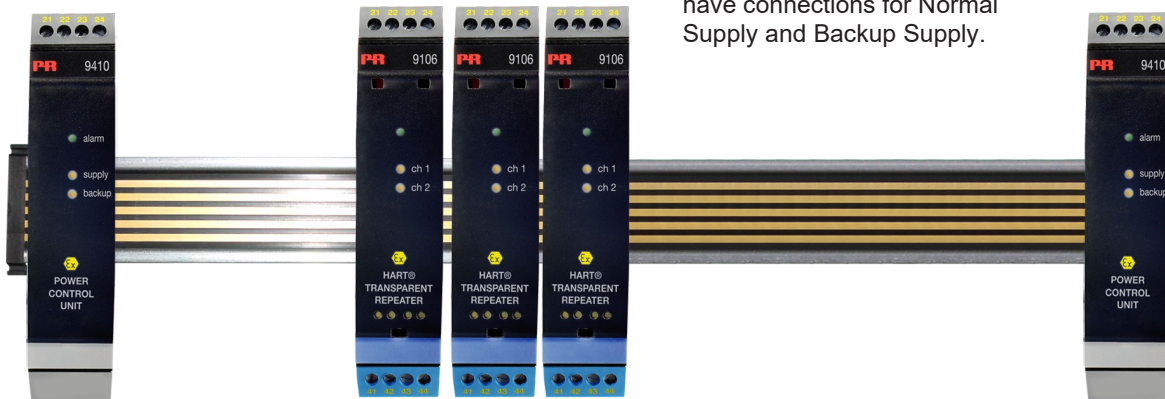

General Installation Instructions

The 9410 must be supplied from a Power Source with Double or Reinforced insulation to Mains

Terminal blocks:

Wire size	0.13-2.08 mm ² / AWG 26-14 stranded wire
Screw terminal torque	0.5 Nm
Wire stripping length	5mm alternatively using bootlace ferrules or similar

Specific Condition of Use

The Power Control Unit Type 9410 and Power Rail Type 9400 shall be installed in a controlled environment with suitably reduced pollution, limited to pollution degree 2 or better.

The circuit shall be limited to overvoltage category I/II as defined in EN60664-1.

The 9410 Power Control Unit and 9400 Power Rail must be installed in an outer enclosure having an IP protection of at least IP54 conforming to the requirements of explosion protection Ex-e.

Transients are suppressed by an internal transient protection device, which is set to a level not exceeding 140% of the rated voltage.

WARNING: Do not separate connectors when energized and an explosive gas mixture is present.

WARNING: Do not install or remove modules from the Power Rail unless Area is known to be Non-Hazardous.

WARNING: Terminals 91,92,93,94,95 may only be connected to Power Rail 9400.

LERBAKKEN 10, 8410 RØNDE DENMARK

FM Installation drawing

9410 Power Control Unit

For safe installation of 9410 the following must be observed. The module shall only be installed by qualified personnel who are familiar with the national and international laws, directives and standards that apply to this area.



Non Hazardous Area or Division 2 / Zone 2

T4: -20 °C < Ta < +60°C

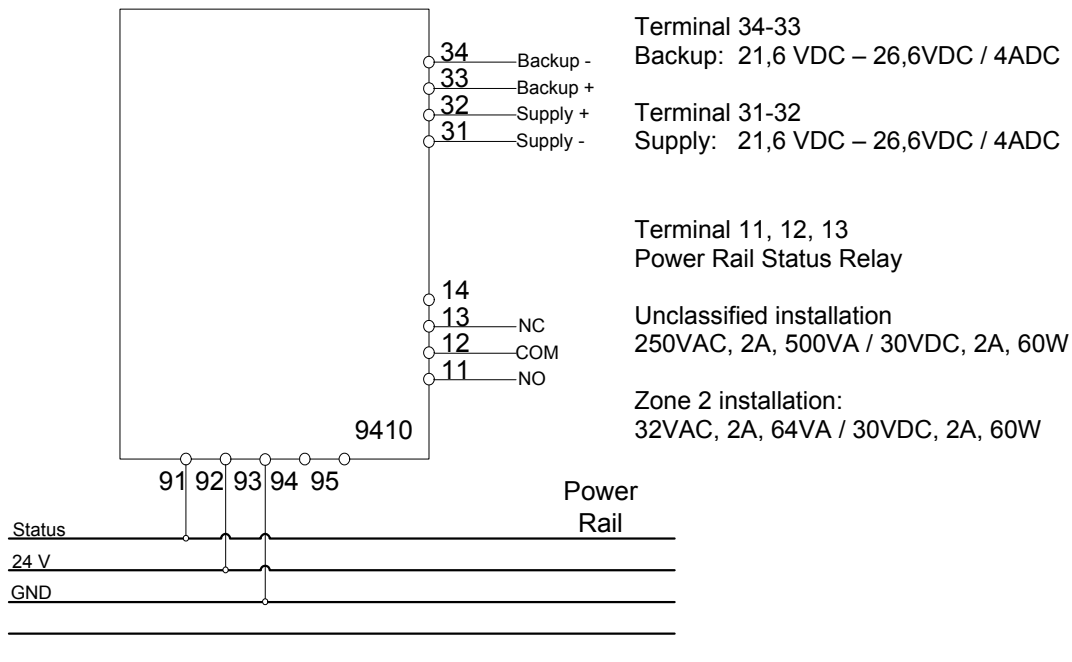

LERBAKKEN 10, 8410 RØNDE DENMARK

9410 Power Control with backup.



Use Endcaps to prevent the Power Rail from being short circuit by the outer enclosure.

Use 9400 Cover to prevent open Power Rail from unintentional short circuit.

Redundant 9410 Power Control with Backup.

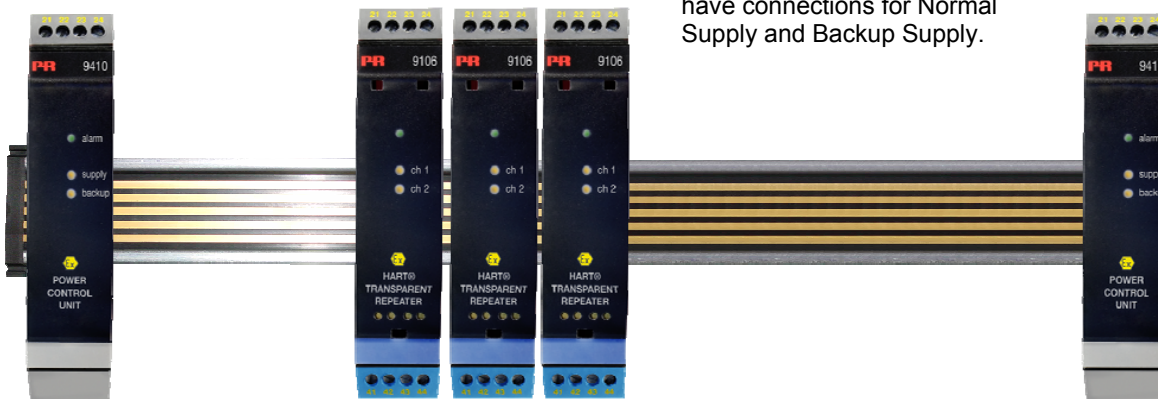

Power is supplied to the Power Rail from two 9410 Power Control Modules. Both modules have connections for Normal Supply and Backup Supply.

LERBAKKEN 10, 8410 RØNDE DENMARK

Installation notes:

The installation and wiring shall be in accordance with the Canadian Electrical Code for Canada and National Electrical Code NFPA 70, Article 500 or 505 for installation in USA.

The module must be supplied from a Power Supply having double or reinforced insulation.

The use of stranded wires is not permitted for mains wiring except when wires are fitted with cable ends.

For installation in Zone 2 or Division 2, the module must be installed in a suitable outer enclosure according to the regulations in the CEC for Canada or NEC for USA.

Shall be installed in compliance with the enclosure, mounting, spacing and segregation requirements of the ultimate application, including a tool removable cover.

Install in pollution degree 2 or better.

Substitution of components may impair the suitability for division 2 / zone 2 installation.

Warning: To prevent ignition of the explosive atmospheres, disconnect power before servicing and do not separate connectors when energized and an explosive gas mixture is present.

WARNING: Do not install or remove modules from the Power Rail and do not remove connectors from the module unless Area is known to be Non Hazardous.

LERBAKKEN 10, 8410 RØNDE DENMARK

UL Installation drawing



For safe installation of the Process Control Equipment 9410-U9, the following must be observed. The module shall only be installed by qualified personnel who are familiar with the national and international laws, directives and standards that apply to this area.

Model: 9410-U9 Power Control Unit

Marking:



Proc. Cont. Eq. for Use in Haz. Loc.
Install in CL I DIV2 GP A-D T4
or CL I Zn2 Gp IIC T4
E233311 Installation Drawing: 9410QU01

The 9410-U9 equipment is intended for installation in non-classified locations or Class I, Division 2, Groups A – D or Zone 2 Group IIC hazardous locations.

Standards:

- UL 121201 NONINCENDIVE ELECTRICAL EQUIPMENT FOR USE IN CLASS I AND II, DIVISION 2 AND CLASS III, DIVISIONS 1 AND 2 HAZARDOUS (CLASSIFIED) LOCATIONS Edition 9 - Revision Date 2018/08/31
- CSA C22.2 NO. 213 NONINCENDIVE ELECTRICAL EQUIPMENT FOR USE IN CLASS I AND II, DIVISION 2 AND CLASS III, DIVISIONS 1 AND 2 HAZARDOUS (CLASSIFIED) LOCATIONS- Edition 3 - Issue Date 2017/09/01

Revision date:
2019-11-18

Version Revision
V1 R0

Prepared by:
PB

Page:
1/3

LERBAKKEN 10, 8410 RØNDE DENMARK

Installation notes 9410-U9

The module must be installed in a tool-secured enclosure suitable for the application in accordance with the National Electrical Code (ANSI/NFPA 70) for installation in the United States, the Canadian Electrical Code for installations in Canada, or other local codes, as applicable.

Install in pollution degree 2, overvoltage category II in accordance with IEC 60664-1.

Use minimum 75 °C copper conductors with wire size AWG: (26-14)

There are no serviceable parts in the equipment and no component substitution is permitted

Warning: To prevent ignition of the explosive atmospheres, disconnect power before servicing and do not separate connectors, install or remove modules from Power Rail when energized and an explosive gas mixture is present.

Avertissement : Pour éviter l'inflammation d'atmosphères explosibles, déconnectez l'alimentation avant les opérations d'entretien. Ne montez pas ou n'enlevez pas les connecteurs quand le module est sous tension et en présence d'un mélange de gaz. Ne montez pas ou n'enlevez pas les modules du rail d'alimentation en présence d'un mélange de gaz..

The 9410-U9 must be supplied from a Power Source with Double or Reinforced insulation to Mains.

Non Hazardous Area or Zone 2

T4: -20 °C <Ta < +60°C

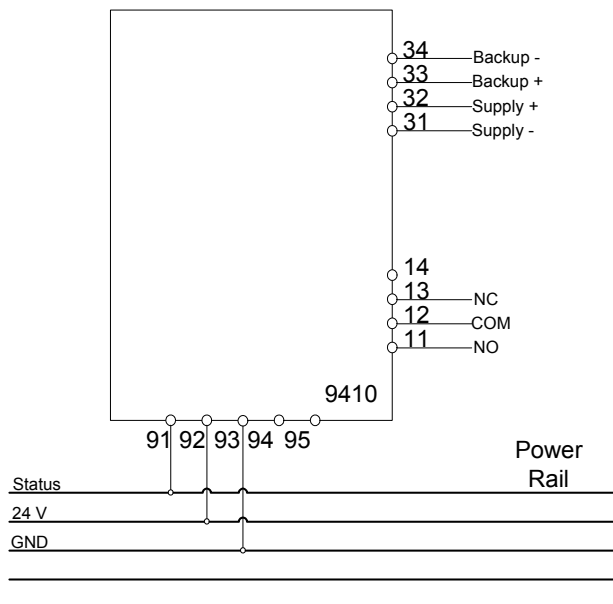

Terminal 34-33
Backup: 21,6 VDC – 26,4VDC / 4ADC

Terminal 31-32
Supply: 21,6 VDC – 26,4VDC / 4ADC

Terminal 11, 12, 13
Power Rail Status Relay

Unclassified installation
250VAC, 2A, 500VA / 30VDC, 2A, 60W

Zone 2 installation:
32VAC, 2A, 64VA / 30VDC, 2A, 60W

LERBAKKEN 10, 8410 RØNDE DENMARK

9410 –U9 Power Control with backup.



Use Endcaps to prevent the Power Rail from being short circuit by the outer enclosure.

Use 9400 Cover to prevent open Power Rail from unintentional short circuit.

Redundant 9410-U9 Power Control with Backup.

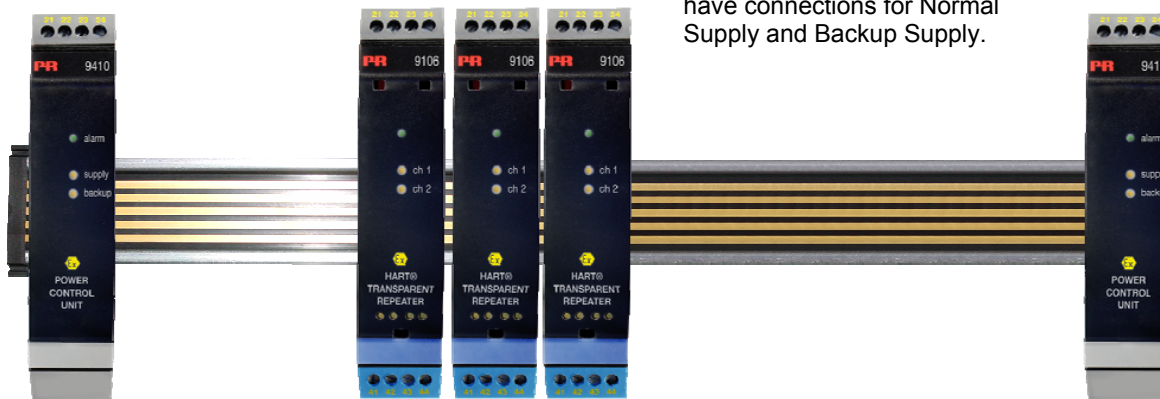

Power is supplied to the Power Rail from two 9410-U9 Power Control Modules. Both modules have connections for Normal Supply and Backup Supply.

LERBAKKEN 10, 8410 RØNDE DENMARK

INMETRO Desenhos para Instalação



9410

Para instalação segura do 9410 o manual seguinte deve ser observado. O módulo deve ser instalado somente por profissionais qualificados que estão familiarizados com as leis nacionais e internacionais, diretrizes e normas que se aplicam a esta área.

Ano de fabricação pode ser obtido a partir dos dois primeiros dígitos do número de série.

9410 Unidade de Controle de Potência

INMETRO Certificado DEKRA 16.0007X

Marcas: Ex ec nC IIC T4 Gc

Normas: ABNT NBR IEC60079-0:2013/2016, ABNT NBR IEC60079-15:2012, ABNT NBR IEC60079-07:2018

Área não classificada ou Zone 2

T4: -20 °C <Ta < +60°C

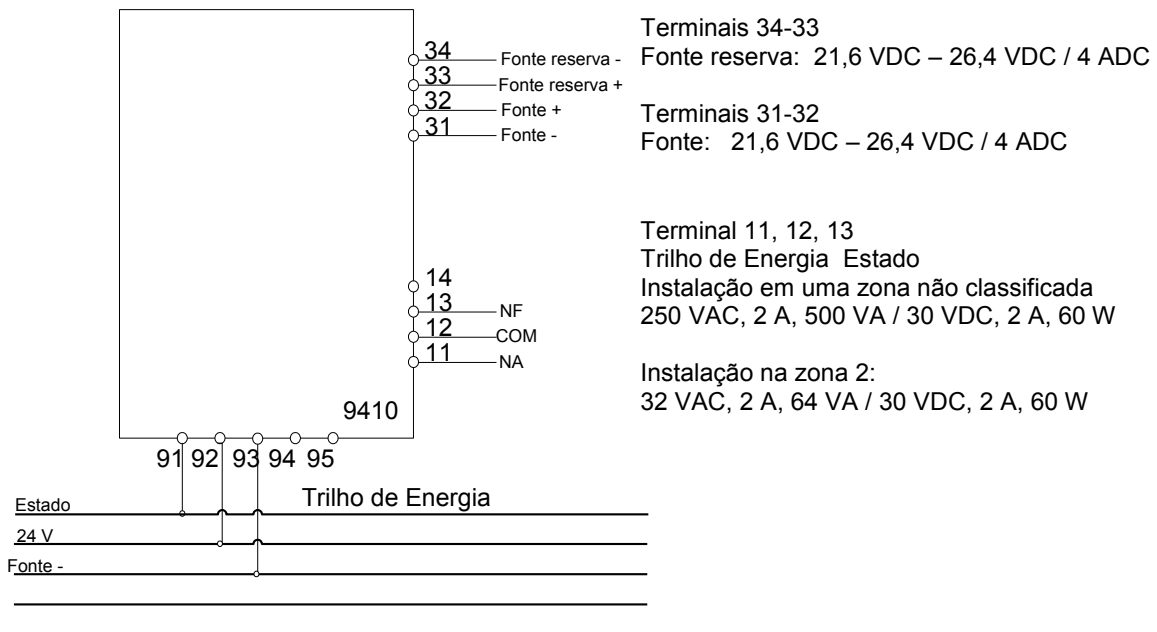

LERBAKKEN 10, 8410 RØNDE DENMARK

9410 Controle de Potência com reserva.

Use Tampas para evitar que o trilho de alimentação entre em curto-circuito com invólucro externo.



Use a capa do 9400 para prevenir que a abertura do trilho de energia e causar curto-circuito não intencional

A energia é fornecida ao barramento de alimentação de dois módulos de controle de energia 9410. Ambos os módulos têm conexões para a fonte de alimentação normal e a fonte reserva.

Controle de Potencia 9410 redundante com reserva

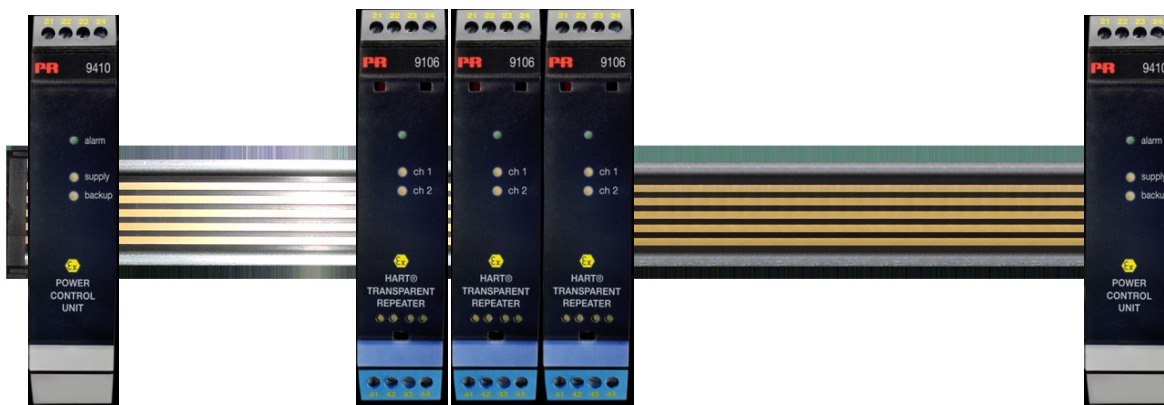

LERBAKKEN 10, 8410 RØNDE DENMARK

Notas para Instalação:

Geral

O 9410 deve ser energizado por uma fonte de alimentação com isolamento duplo ou reforçado vindo da rede elétrica.

Blocos de terminais :

tamanho do fio 0,13-2,08 mm² / AWG 26-14 encachado

Torque terminal < 0,5 Nm

Para instalação em Zona 2

A unidade de controle de potência tipo 9410 e o tipo de trilho de energia 9400 devem ser instalados em um ambiente controlado com poluição adequadamente reduzida, limitada ao grau de poluição 2 ou melhor.

O circuito deve ser limitado à categoria de sobretensão I / II, conforme definido na IEC 60664-1.

O Unidade de controle de Potência Modelo 9410 e Trilho de Alimentação Modelo 9400 deve ser instalado dentro de um invólucro adequado em conformidade com o tipo de proteção 'Ex n' ou 'Ex e', fornecendo no mínimo grau de proteção IP54.

Transientes são suprimidos por um dispositivo interno, que é definido para um nível não superior a 40% da tensão nominal.

Atenção: Não desconecte conectores quando energizado e uma mistura explosiva de gás estiver presente.

Atenção: Não instalar ou remover os módulos do trilho de energia a menos que área seja conhecida como área não classificado.

Atenção: Terminais 91, 92, 93, 94 e 95 só podem ser conectados ao Trilho de Energia Typo 9400.

IECEX 설치 도면

9410

9410의 안전한 설치를 위해 다음 사항을 준수해야 합니다. 이 모듈은 이 지역에 적용되는 국내 및 국제 법률, 지침 및 표준에 정통한 유자격자만 설치해야 합니다.

제조연도는 일련번호의 처음 두 자리입니다.



9410 전력 제어 장치

IECEX 인증서 IECEX KEM 08.0025 X

마킹: Ex ec nC IIC T4 Gc

표준: IEC60079-0:2017, IEC60079-15:2017, IEC60079-7:2017

비위험 지역 또는 구역 2

T4: -20 °C < Ta < +60°C

단자 34-33

백업: 21.6 VDC – 26.6 VDC / 4 ADC

단자 31-32

공급: 21.6 VDC – 26.6 VDC / 4 ADC

단자 11, 12, 13

파워 레일 상태 릴레이

비분류 설치

250 VAC, 2 A, 500 VA / 30 VDC, 2 A, 60 W

구역 2 설치:

32 VAC, 2 A, 64 VA / 30 VDC, 2 A, 60 W

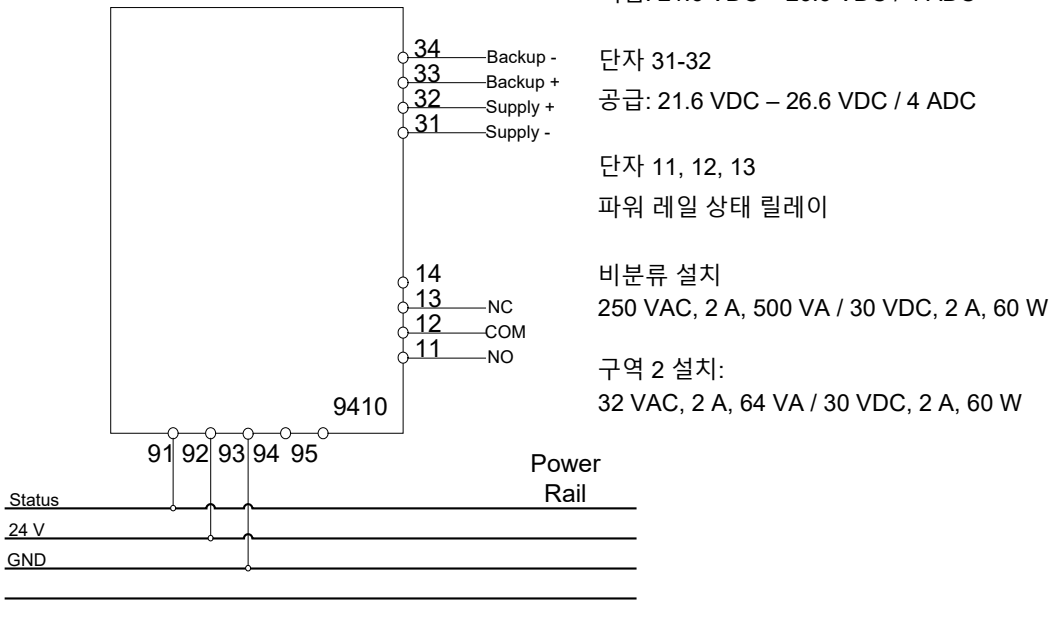

백업 기능이 있는 9410 전력 제어.



외부 인클로저에 의해 파워 레일이 단락되는 것을 방지하려면 엔드 캡을 사용하십시오.

파워 레일이 의도치 않게 단락되는 것을 방지하려면 9400 커버를 사용하십시오.

백업 기능이 있는 이중 9410 전력 제어.



전원은 2개의 9410 전력 제어 모듈에서 파워 레일로 공급됩니다. 두 모듈이 모두 정상 공급 및 백업 공급을 위한 연결을 갖고 있습니다.

설치 참고 사항:

일반 사항

9410은 주 전원에 대하여 이중 또는 강화 절연이 있는 전원으로부터 공급 받아야 합니다.

단자 블록:

와이어 크기 0.13-2.08 mm² / AWG 26-14 연선
나사 단자대 토크 0.5 Nm

구역 2에 설치하는 경우

전력 제어 장치 유형 9410 및 파워 레일 유형 9400은 오염이 적절히 감소된 통제된 환경(오염도 2 이상으로 제한)에 설치해야 합니다.

회로는 IEC 60664-1에 정의된 대로 과전압 범주 I/II로 제한해야 합니다.

9410 전력 제어 장치 및 9400 파워 레일은 방폭 Ex-n 또는 Ex-e의 요구 사항을 준수하는 IP 보호가 IP54 이상인 외부 인클로저에 설치해야 합니다.

과도 현상은 정격 전압의 40%를 초과하지 않는 수준으로 설정된 내부 과도 보호 장치에 의해 억제됩니다.

경고: 전원이 공급되고 폭발성 가스 혼합물이 있는 경우, 커넥터를 분리하지 마십시오.

경고: 지역이 위험하지 않은 것으로 알려진 경우가 아니면 파워 레일에 모듈을 설치하거나 제거하지 마십시오.

경고: 단자 91,92,93,94,95는 파워 레일 9400에만 연결할 수 있습니다.

Document history

The following list provides notes concerning revisions of this document.

Rev. ID	Date	Notes
103	1907	New INMETRO certificate and installation drawing.
104	1949	Variant with UL 913 approval added.
105	2033	New FM certificate and installation drawing. ATEX, IECEx and INMETRO installation drawings updated.
106	2103	CCC approval added.
107	2315	ATEX and IECEx approvals updated - Ex nA changed to Ex ec. UKEX approval added. Variant with Korean KCs approval added.

We are near you, *all over the world*

Our trusted red boxes are supported wherever you are

All our devices are backed by expert service and a 5-year warranty. With each product you purchase, you receive personal technical support and guidance, day-to-day delivery, repair without charge within the warranty period and easily accessible documentation.

We are headquartered in Denmark, and have offices and authorized partners the world over. We are a local

business with a global reach. This means that we are always nearby and know your local markets well. We are committed to your satisfaction and provide **PERFORMANCE MADE SMARTER** all around the world.

For more information on our warranty program, or to meet with a sales representative in your region, visit prelectronics.com.

Benefit today from *PERFORMANCE MADE SMARTER*

PR electronics is the leading technology company specialized in making industrial process control safer, more reliable and more efficient. Since 1974, we have been dedicated to perfecting our core competence of innovating high precision technology with low power consumption. This dedication continues to set new standards for products communicating, monitoring and connecting our customers' process measurement points to their process control systems.

Our innovative, patented technologies are derived from our extensive R&D facilities and from having a great understanding of our customers' needs and processes. We are guided by principles of simplicity, focus, courage and excellence, enabling some of the world's greatest companies to achieve PERFORMANCE MADE SMARTER.